

Labyrinth Buffet

Item Code: 24128094

Thank you for purchasing the Labyrinth Buffet. Before you begin to assemble your new piece of furniture, please check to ensure that all hardware and parts have been supplied. This page lists all contents included in the carton(s).

Follow instructions closely as deviation from them may present a possible safety risk and may void your warranty.

It is recommended that assembly is done on a soft surface such as carpet to avoid any damage.

If you experience any problems with your new purchase, please contact Freedom Customer Service via www.freedom.com.au (Australia) or www.freedomfurniture.co.nz (New Zealand).

Care Information

- Use table cloths, table runners and coasters to help protect surfaces from scratching. Certain ranges have a more raw appearance to accentuate their beauty and require extra care. These include white-wash finishes.
 - Treat spills quickly with a damp cloth
 - Dust once a week using a soft cloth or similar duster. Dust in the direction of the grain where possible.
 - Use felt pads on the base of vases or similar items to avoid scratching. Be aware that certain materials such as rubber leg glides on electronic devices and vinyl can react with timber and mark it.
 - Only use recommended care products as many supermarket polishes and waxes contain high levels of silicon and petroleum distillate which can damage the surface. Freedom recommends using the Indoor Timber Protection Kit. This kit comes with a cleanser/conditioner, a protective cream and reusable microfiber cloth.
 - Periodically check and re-tighten any fasteners.

 - Although we test our finishes for resistance to heat and stains you should always avoid placing hot or wet items directly on the surface as they can leave marks which are difficult to remove. Where joints or veneers meet, it can cause swelling or splitting.
 - Avoid direct sunlight, as this will cause color change. If the furniture is in direct sunlight, move items like vases around to avoid spotting.
 - Don't place potted plants on timber or veneers unless it is water tight or in a tray.
 - Avoid applying too much care product as this will build up and need to be removed with a wood-cleaning product. Avoid supermarket polishes and waxes as many contain high levels of silicon and petroleum distillate which can damage the surface.
 - Timber designed for indoor use should not be left outside. Its finish is not designed for use outdoors.
- A number of our furniture ranges are unique handmade items. While great care is taken during production there can be slight variations which is part of the charm and appeal of handcrafted timber product and not a manufacturing defect.

Labyrinth Buffet

Item Code: 24128094

Hardware (Supplied)

(A) PVC Bracket, 2x

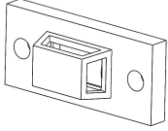

(B) PVC Cable Tie, 2x



(C) Shelf Pin, 12x



Parts

(X) Cabinet - 1x

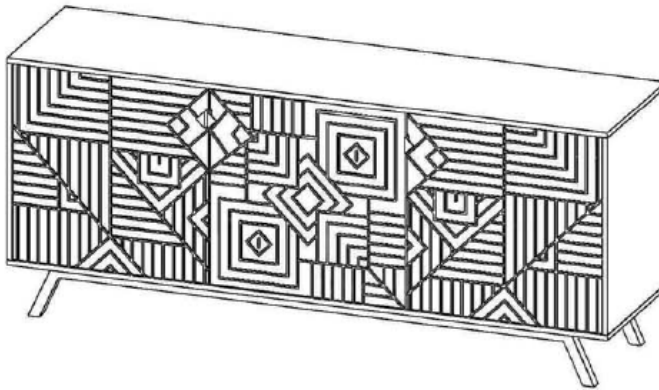

(Y) Shelf - 3x

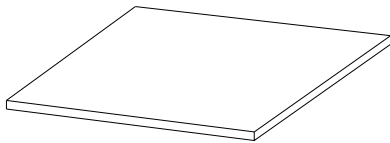

Page 3 of 6

Labyrinth Buffet

Item Code: 24128094

Step 3.

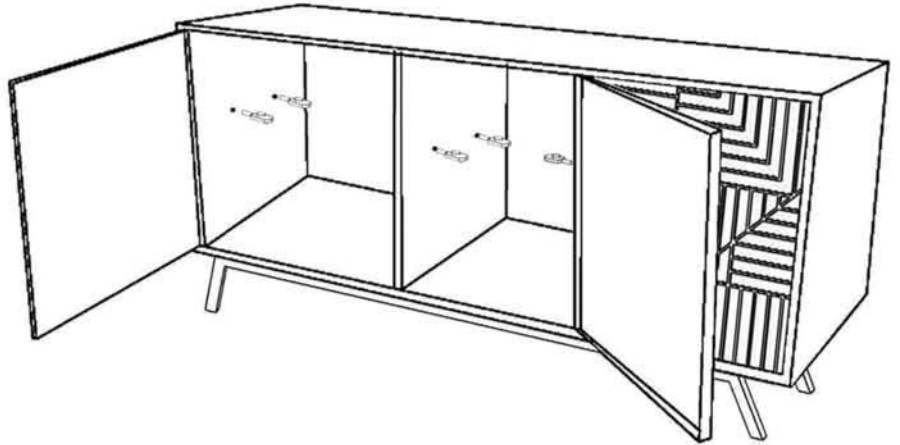
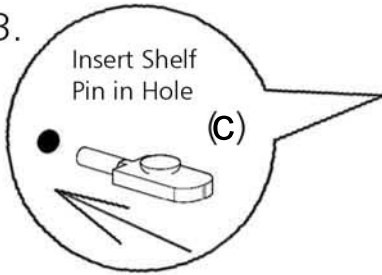

Step 4.

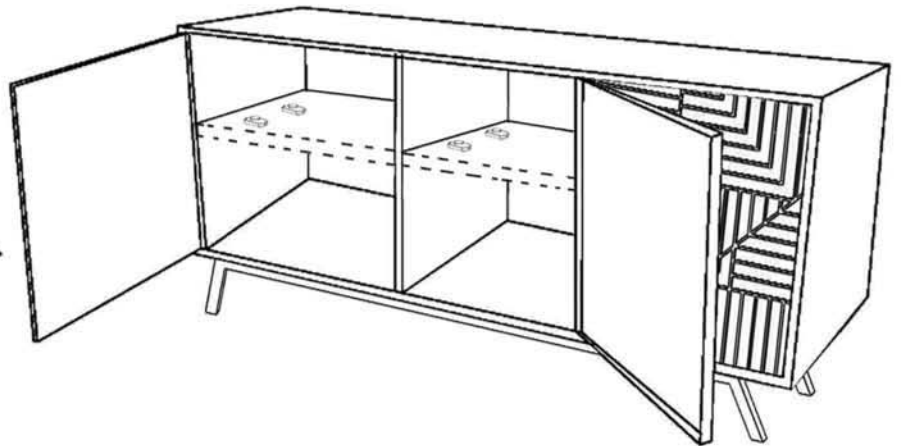
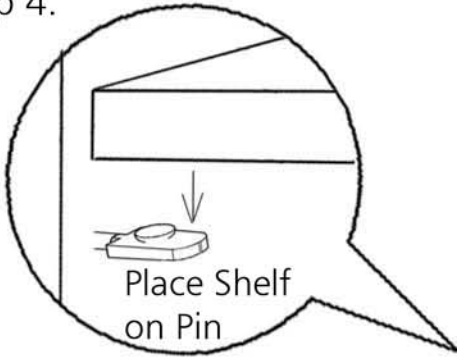

Step 5.

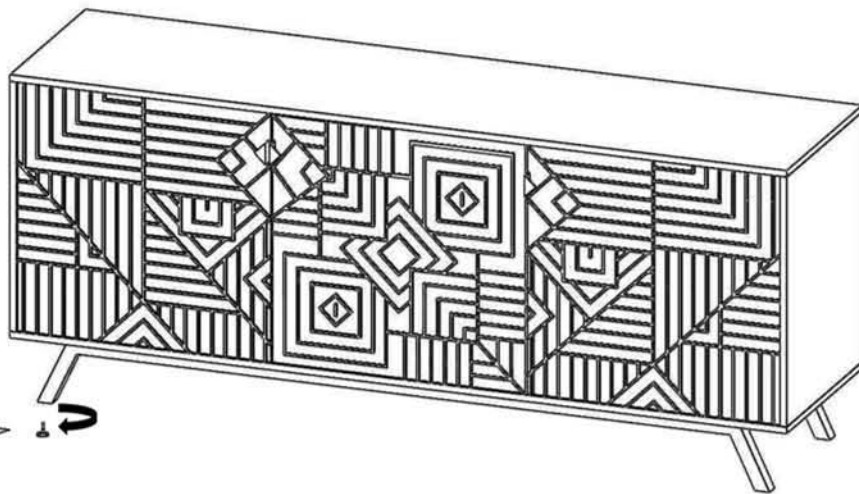
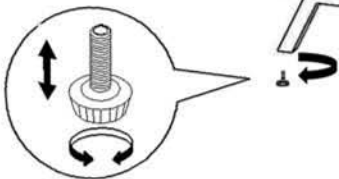

FREEDOM

Labyrinth Buffet

Item Code: 24128094

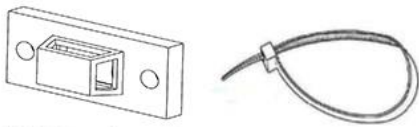

(c) PVC Bracket, 2x (D) PVC Cable Tie, 2x

2 Clips at the back of the Cabinet will be pre-fixed (as shown in the picture)

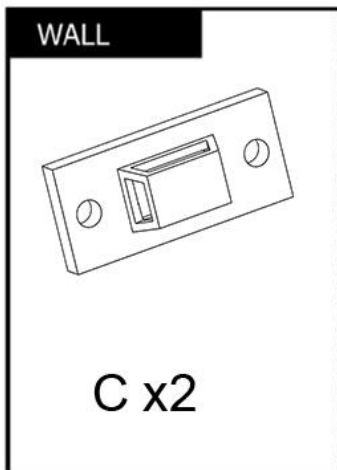

Step 3.

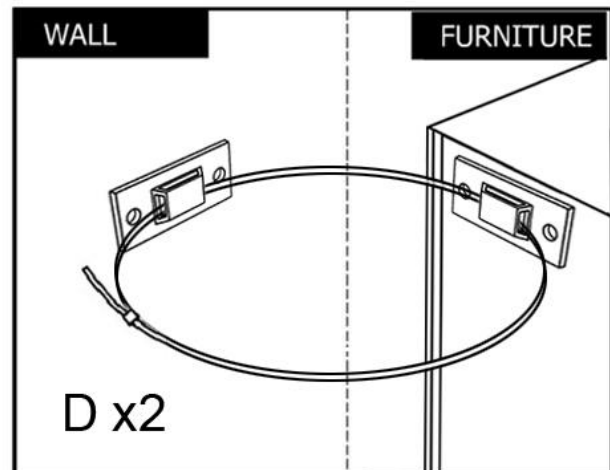

Step 4.

WARNING:

To prevent your furniture from tilting forward and possibly causing property damage or personal injury it is recommended that you Securely attach the anti-tilt straps or brackets provided to your wall using appropriate fixings

IMPORTANT:

- DO NOT place toys or other child appealing items on top of this furniture
- AVOID fully opening all drawers at the same time
- DO NOT ALLOW Small children to climb onto Drawers, shelves or to swing from open doors

CAUTION:

For your safety when attaching the anti-tilt fixings;

- Check for any electrical wires or plumbing inside the wall before drilling any holes (if you are unsure please seek professional advice from a qualified tradesman)
- Walls are constructed from different materials eg; Masonry (solid brick) or plaster board lined cavity walls (hollow).

It is important that you use the appropriate wall fixings for your wall type.

(Your local hardware store will have the necessary drills and fixings and can offer advice if needed).

Labyrinth Buffet

Item Code: 24128094

Assembly Instructions

Hinge Adjustment

- Follow instructions closely as deviation from them may void your warranty and present a possible safety risk.
- If you experience any problems with your new purchase please phone Freedom Customer Service (FCS) on 1300 135 588 (Customers outside Australia should contact their closest Freedom store.)

Lateral Movement

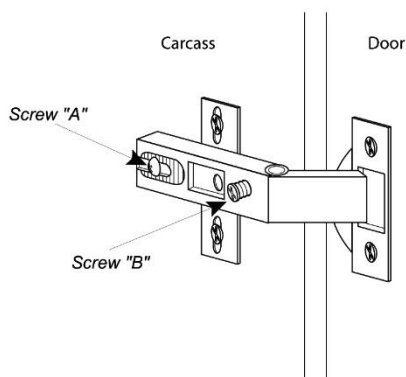
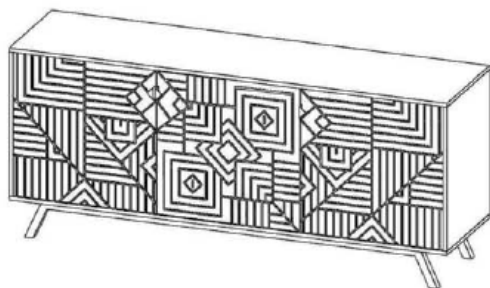

What it looks like

- The door will not be flush with the side panel.

How to fix it

- To move the door towards the centre of the unit, loosen Screw "A". Adjust the door and then tighten Screw "B".
- To move the door away from the centre of the unit, loosen Screw "B". Adjust the door and then tighten Screw "A".

Labyrinth Buffet

Item Code: 24128094

Assembly Instructions

Hinge Adjustment

Vertical Movement

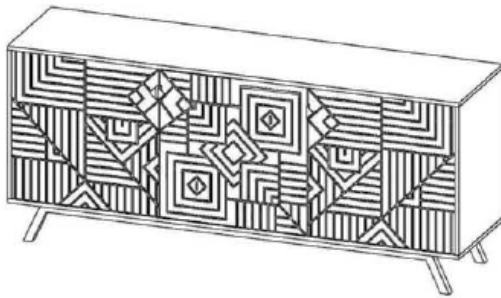

What it looks like

- The door will not be flush with the vertical panel.

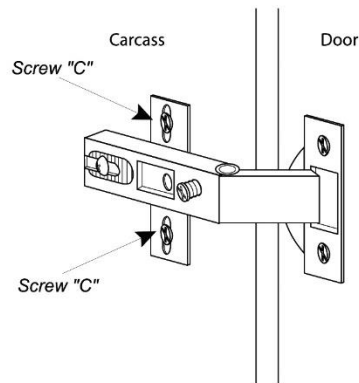

How to fix it

- To move the door towards or away from the horizontal panels, loosen Screws "C". Adjust the door and then tighten Screws "C".

Horizontal Movement

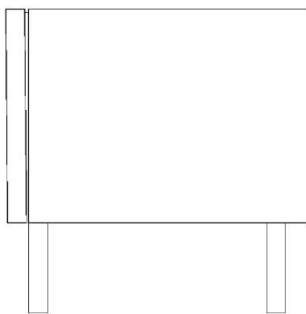

What it looks like

- The door will appear too far or too close from the front edge of the side panel.

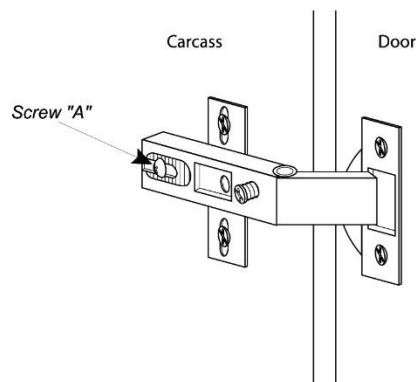

How to fix it

- To move the door towards or away from the unit, loosen Screw "A". Adjust the door forwards or backwards until there is an even gap between the door and the front edge of the side panel.
- Tighten Screw "A" once the adjustment has been made.