

# KASPAR DRESSER 4 DRAWER OAK

## 24132015

Thank you for purchasing the Kaspar Dresser 4 Drawer Oak. Before you begin to assemble your new piece of furniture, please check to ensure that all hardware and parts have been supplied. This page lists all contents included in the carton(s).

Follow instructions closely as deviation from them may present a possible safety risk and may void your warranty.

It is recommended that assembly is done on a soft surface such as carpet to avoid any damage. If you experience any problems with your new purchase, please contact Customer Service via the website [www.freedom.com.au](http://www.freedom.com.au) or [www.freedomfurniture.co.nz](http://www.freedomfurniture.co.nz)

### Care Information

- Dust once a week using a soft cloth or similar duster.
- Only use freedom recommended care products as many supermarket polishes and waxes contain high levels of silicon and petroleum distillate which can damage the surface.
- Polish your furniture every 3 to 6 months, making sure the surface is free from dust before you start.
- Avoid placing hot or wet items directly on the surface as they can leave marks which are difficult to remove.
- Avoid direct sunlight, as this will cause colour change. If the furniture is in direct sunlight, move items like vases around to avoid spotting.
- Avoid applying too much polish as this will build up and need to be removed with a wood-cleaning product.

### Hardware (Not Supplied)

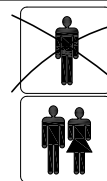
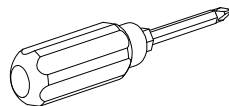

### Parts

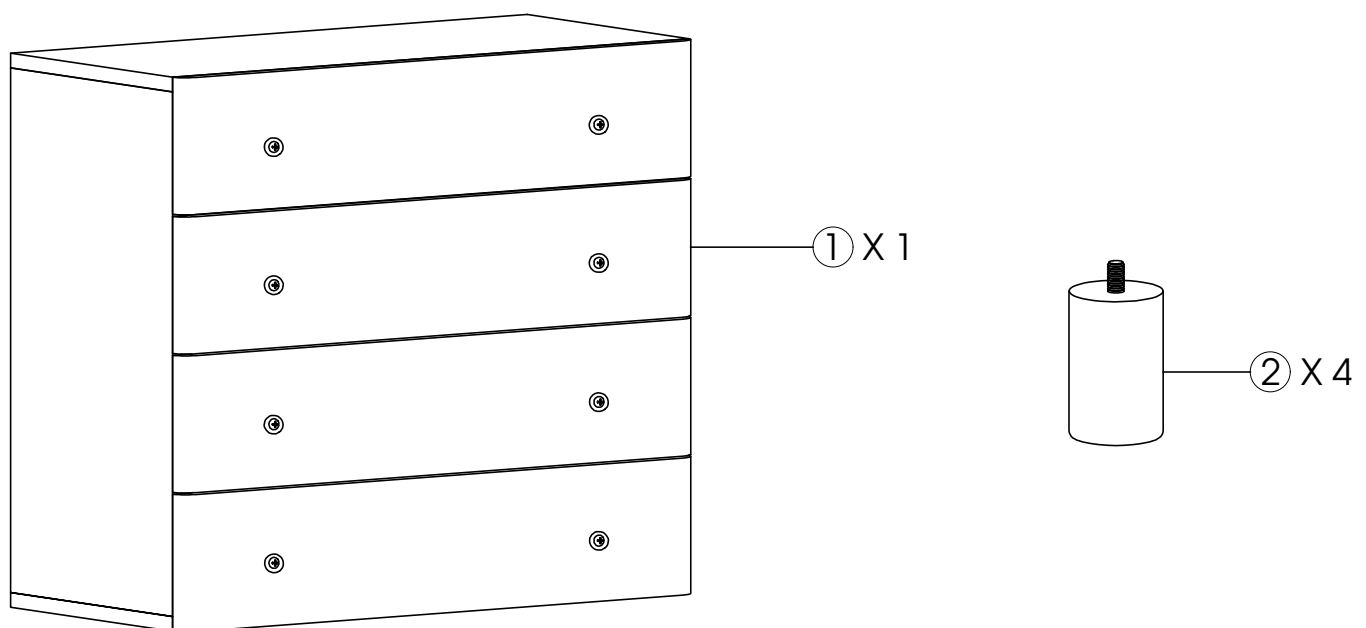

# KASPAR DRESSER 4 DRAWER OAK

## 24132015

### Step 1

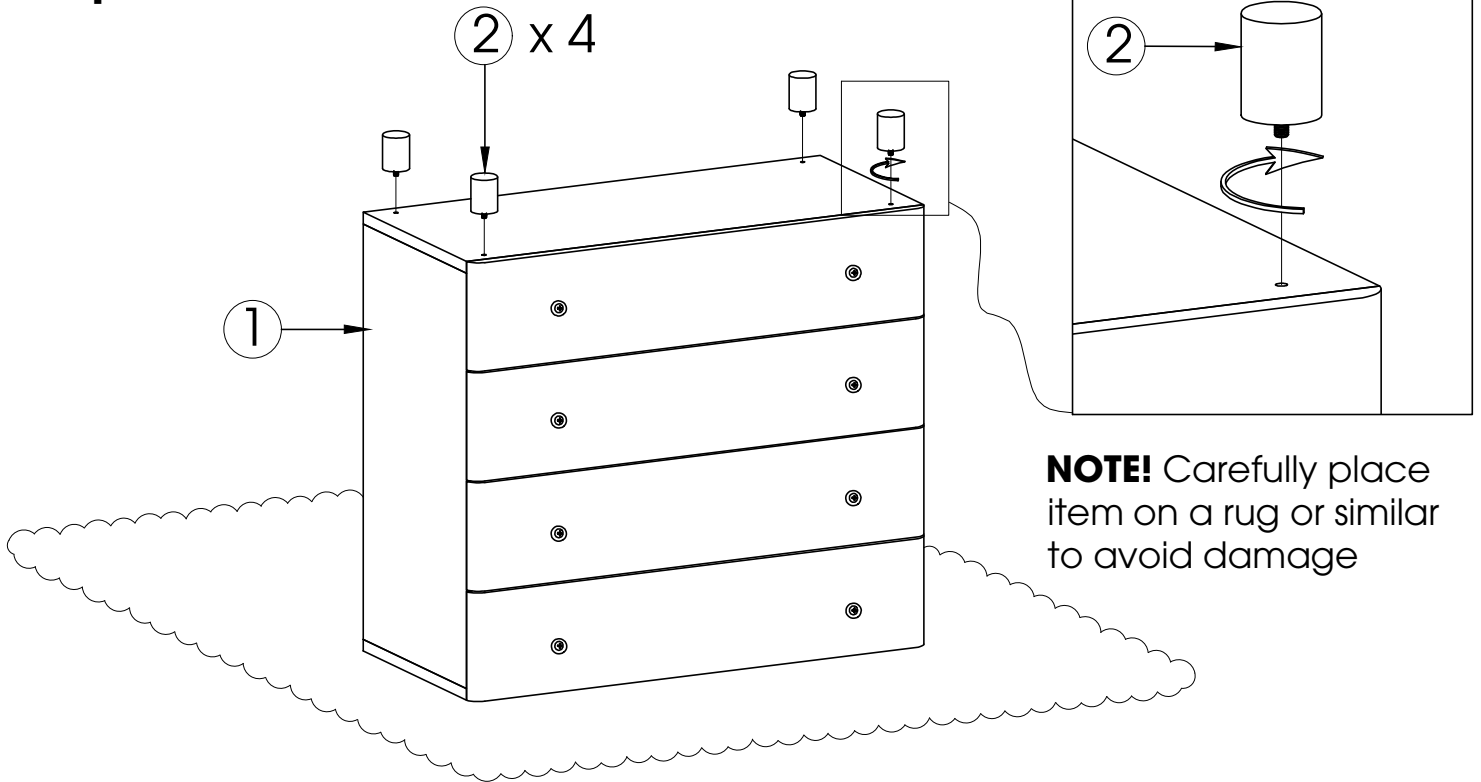

### Step 2

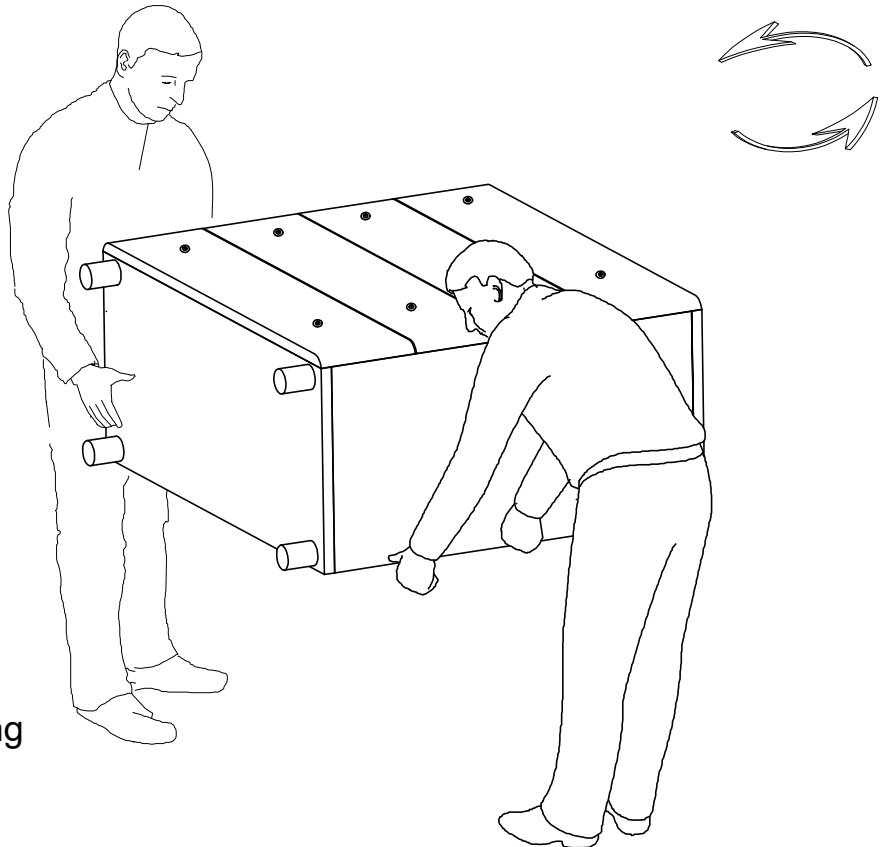

**NOTE!**

At least two people should complete this step.  
Do not leverage the item using the legs as it will cause damage.

# KASPAR DRESSER 4 DRAWER OAK

## 24132015

### Step 3

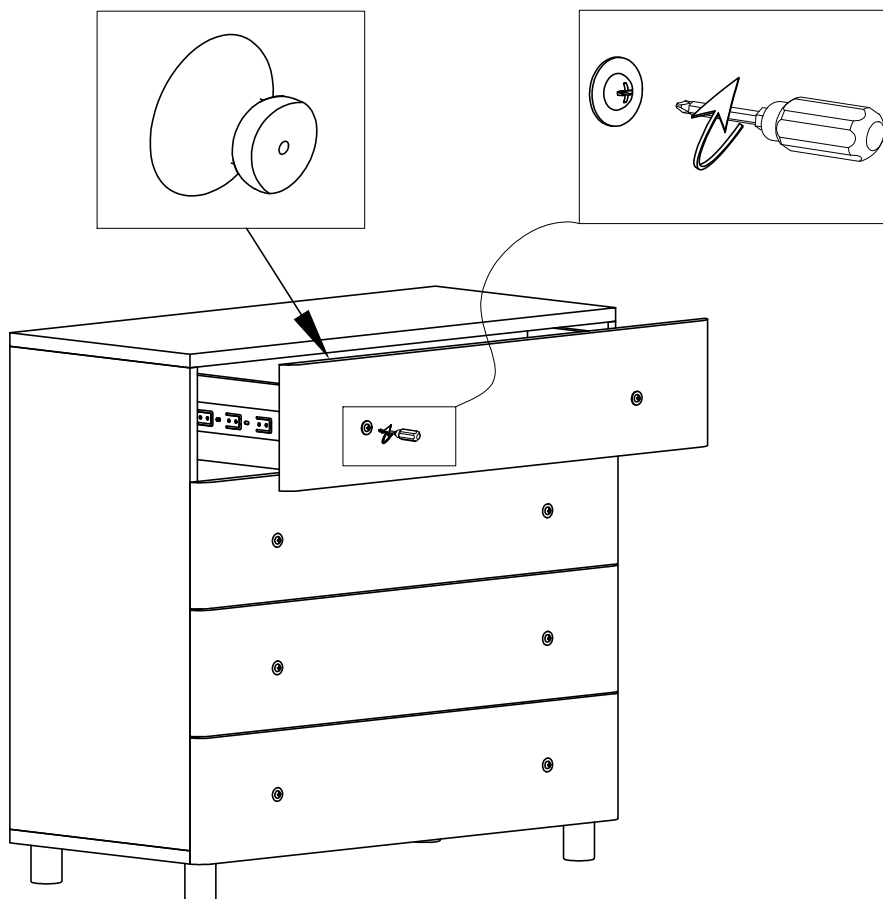

### Step 4

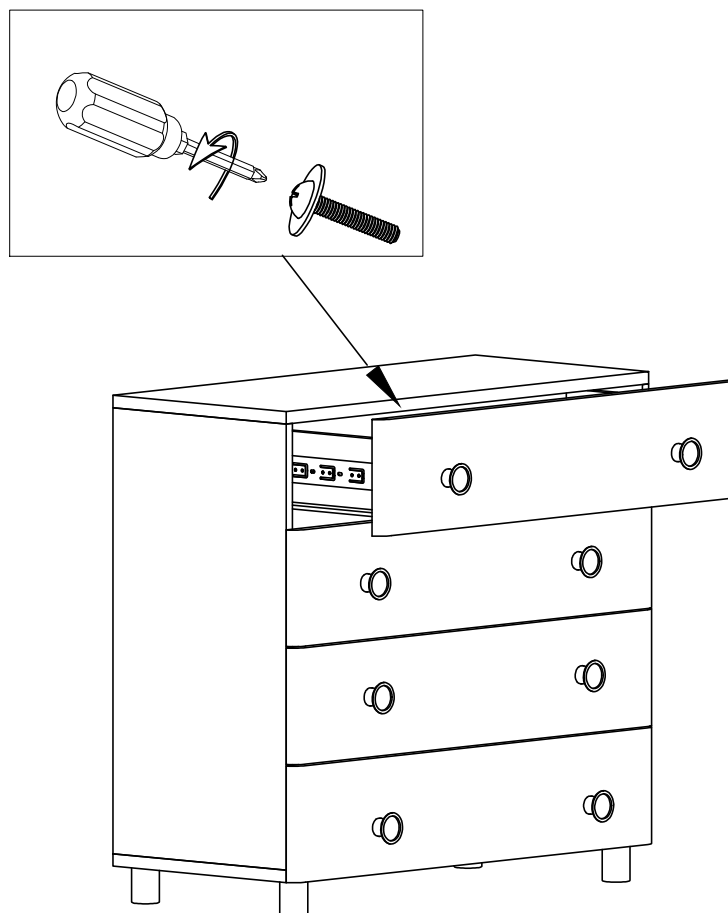

# KASPAR DRESSER 4 DRAWER OAK

## 24132015

**FINAL Step:** Attach anti tilt strap or bracket to wall

**WARNING:**

To prevent your furniture from tilt forward and possibly causing property damage or personal injury it is recommended that you **Securely attach the anti-tilt traps or brackets provided to your wall using appropriate fixings.**

**IMPORTANT:**

- **DO NOT** place toys or other child appealing items on top of this furniture
- **AVOID** fully opening all drawers at the same time
- **DO NOT ALLOW** Small children to climb onto Drawers, shelves or to swing from open doors.

**CAUTION:**

For your safety when attaching the anti-tilt fixings;

- Check for any electrical wires or plumbing inside the wall before drilling any holes ( if you are ensure please seek professional advice from qualified tradesman.)
- Wall are constructed from different marterials eg: Masonry ( solid brick) or plaster board lined cavity walls ( hollow).

It is important that you use the appropriate wall fixing for your wall type.

**(Your local hardware will have the necessary drills and fixings and can offer advice if**

