

- Thank you for purchasing the **S-fold Curtain Liner**. Please check to ensure that curtain liner and hooks have been supplied. This page lists all contents included in the packaging.
- Follow instructions closely as deviation from them may present a possible safety risk and may void your warranty.

**Care Information**

**S-fold Track:** Remove curtains and regularly vacuum carefully inside track to ensure smooth operation.

**S-fold Liner:** Regularly gently vacuum with appropriate attachment. Do not allow dust to accumulate. Remove hooks before cleaning. Warm hand wash in mild detergent. Do not bleach or soak. Do not rub or wring. Drip dry in shade. do not tumble dry. Do not use pegs or fold over clothesline. For best results, hang curtains by their hooks to damp dry. Do not dry clean. possible shrinkage 3%. Warm iron on fabric side only. 100% Polyester/Acrylic coated.

**IMPORTANT INFORMATION BEFORE YOU BEGIN**

1. Your Freedom S-fold track system should be installed following the instructions in the pack. Please take time to check all screws have been tightened and components are fitted correctly
2. The S-fold Liner curtain you have selected has been designed to fit multiple s-fold track sizes by adjusting the hook spacing accordingly. The following instructions offer a guide to the hook spacing however the spacing may need to be slightly adjusted to ensure all hooks fit into the number S-fold Track carriers of the track size selected.
3. For smooth operation it is recommended to install a hook into every S-fold track carrier. Below is a list of the number of carriers in each size track.
4. S-fold liner curtains are designed to fit behind Freedom S-fold sheer curtains. They do not have the fullness of a regular s-fold curtain, meaning the 'waves' are not as deep. Therefore the liner is less likely to 'catch' on the face curtain ensuring a smoother operation. S-fold liner curtains are not designed to be a stand alone curtain.

5. HOOKS:

The number of hooks in the S-fold Liner pack corresponds to the largest S-fold Track size indicated on the pack:

TRACK SIZE	S-FOLD CURTAIN LINER SIZE	NUMBER OF CARRIERS IN TRACK	NUMBER OF HOOKS REQUIRED	POCKET SPACING
140CM	260CM X 280CM	25	25	4
180CM	260CM X 280CM	32	32	3
220CM	400CM X 280CM	40	40	5
280CM	400CM X 280CM	48	48	4
360CM	400CM X 280CM	62	62	3

Note: creating the perfect folds.

Remember that each fold must have 2 sides, and to create 2 sides there needs to be 2 hooks (fig.5). To ensure perfect folds from start to finish you will need to use an even number of hooks throughout the width of the curtain.

As the tape pockets may be slightly uneven, you will need to adjust the curtain hook positioning slightly.

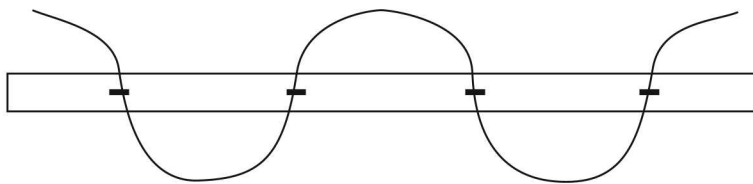

\* top view showing curtain folds

(fig.5)

WARNING: CURTAIN HOOKS ARE SHARP. take care not to place your finger on pointed edge. Wear covered footwear during installation.

1. Lay your curtain on a flat surface with the face side down exposing the specially designed S-fold tape on the reverse side.

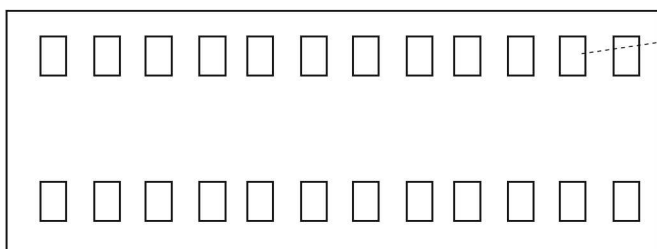

(fig.1)

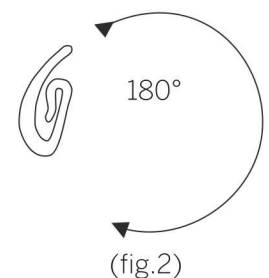

(fig.2)

2. Inserting curtain hooks (fig 1.)

Curtain hooks are inserted into the top row of the tape only. Beginning with the 2nd pocket, insert the curtain hooks into the pocket with the pointed end facing up towards the top of the curtain. Turn the curtain hook over 180° so the pointed end of the curtain hook is now facing downwards.(fig 2.)

Note: beginning with the 2nd pocket ensures the plastic carriers are hidden from sight resulting in a neater finish.

140cm S-fold track size  
260cm x 280cm S-fold curtain liner

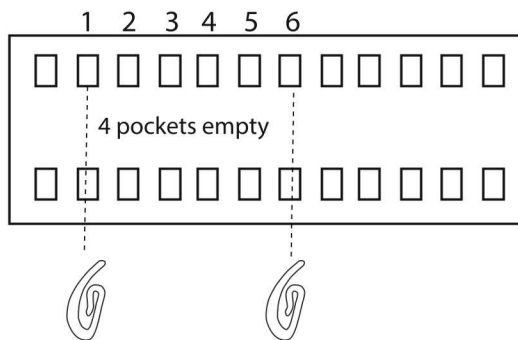

180cm S-fold track size  
260cm x 280cm S-fold curtain liner

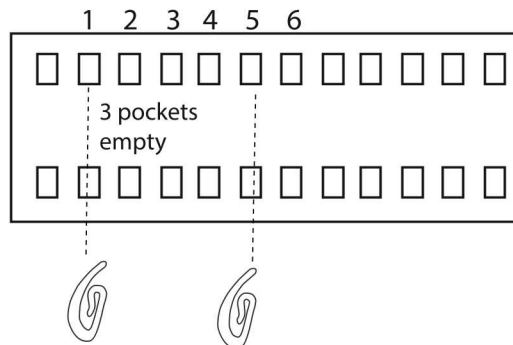

220cm S-fold track size  
400cm x 280cm S-fold curtain liner

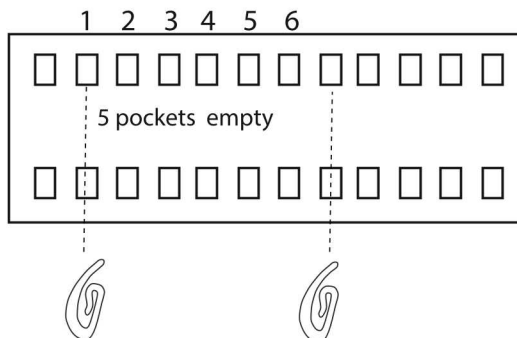

280cm S-fold track size  
400cm x 280cm S-fold curtain liner

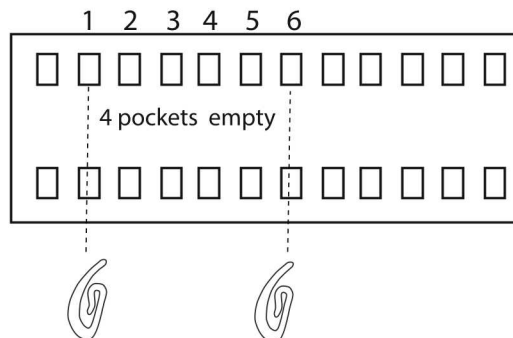

360cm S-fold track size  
400cm x 280cm S-fold curtain liner

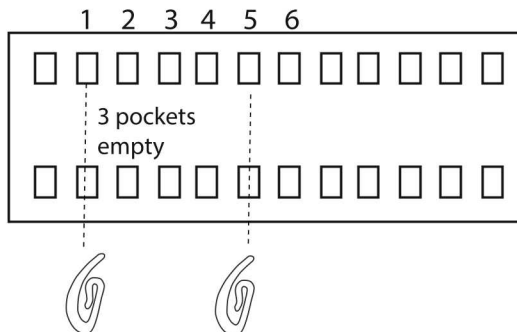

### 3. Hanging your curtains

We recommend 2 persons to hang the S-fold curtains, one person to insert the hooks and the other person holding the curtain. This reduces the pressure on the start of the track when beginning to hang the curtain.

With the fabric side of the curtains facing you, begin at the FIXED END of the curtain track. Insert the pointed end of the curtain hook through the hole in the S-fold carriers ensuring that the pointed section of the hook is pointing in a downwards direction when finished.

Move along the track and insert all curtain hooks into the carriers.

### 4. Adjust the curtain folds

Starting at one end adjust each curtain fold so that the entire curtain forms a series of perfect waves.

### 5. Hemming your curtain (fig.6)

NOTE. We recommend that you leave your S-fold curtains hanging for 1 week to ensure creases have dropped out. Using a warm iron or steam iron on the face side of the fabric to reduce any creases.

Your S-fold curtain pack contains a roll of hemming tape.

Simply pin or mark with chalk your desired curtain length while the curtain is hanging. You may need to cut excess fabric at this point as a maximum hem of 10cm is recommended.

### 6. Using the hemming tape (fig.7)

Place the hemming tape in between the layers of fabric, making sure the fabric is completely covering the tape. important: the tape melts becoming glue and is hot when melted.

You can remove the curtain from the track or iron on the hemming tape while the curtain is hanging.

Using an ironing board, iron on the fabric side of the curtain only. Never iron the coated side of the curt

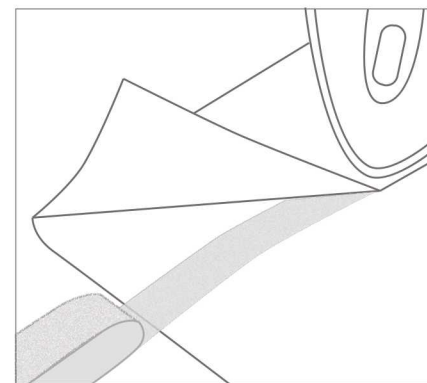

(fig.6)

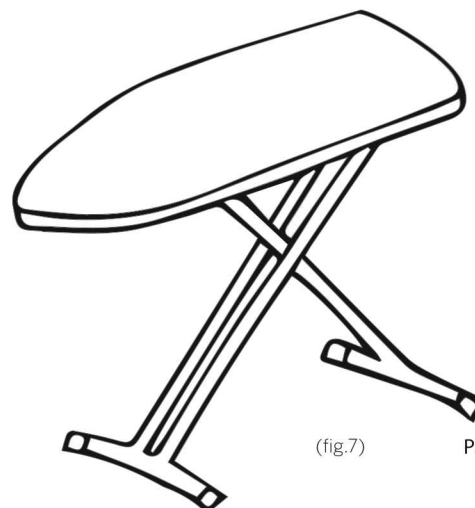

(fig.7)