

# DIAZ TABLE LAMP BLACK

## 24606219

Thank you for purchasing the **DIAZ TABLE LAMP BLACK**. Before you begin to assemble your new lamp, please check to ensure that all hardware and parts have been supplied. This page lists all contents included in the carton(s).

Follow instructions closely as deviation from them may present a possible safety risk and may void your warranty.

It is recommended that assembly is done on a soft surface such as carpet to avoid any damage.

If you experience any problems with your new purchase, please contact Freedom customer service via [www.freedom.com.au](http://www.freedom.com.au) (Australia) or [www.freedomfurniture.co.nz](http://www.freedomfurniture.co.nz) (New Zealand)

### Care Information

Periodically check and re-tighten all fasteners. Wipe down surfaces weekly using a clean cloth. If the external flexible cable or cord is damaged it needs to be replaced by a professional. Ensure screws are fastened firmly as small parts may present as choking hazards.

### Replacing the bulb:

Disconnect the plug from the electrical supply and allow the bulb and lamp to cool down, replace the bulb with an **E27 Max. 40W**. Re-connect the supply and turn on.

### Specifications:

**220-240V ~,50Hz** 

**IP20-Indoor Use only**

**E27 Max. 40W**  **(bulb not included)**

**E27 Max. 9W** 

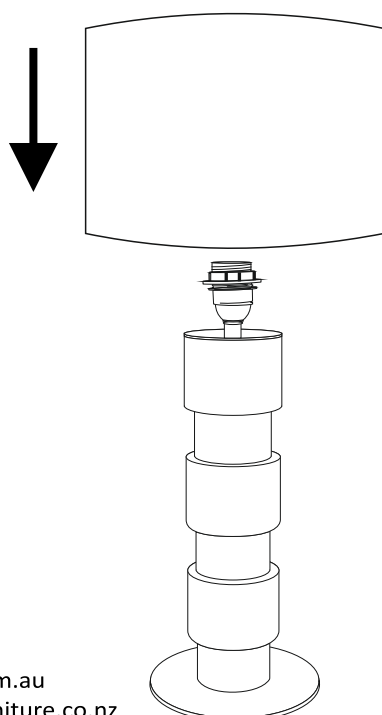

**E27 Max. 15W** 

**Class II protection**

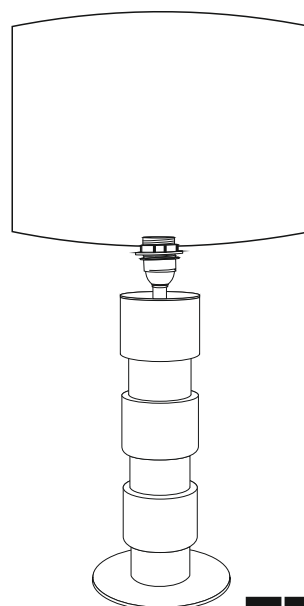

 **E27 Max. 40W**



E27 Max.40W   
E27 Max.9W   
E27 Max.15W 

[www.freedom.com.au](http://www.freedom.com.au)  
[www.freedomfurniture.co.nz](http://www.freedomfurniture.co.nz)

# FREEDOM